



*Think Automation and beyond...*

## **RN Series Universal Relays SN Series Sockets**



---



# RN Series Universal Relays

High performance relays with up to 5A (DPDT) contacts.

## RN Series

Shape	Part No.		Coil Rated Voltage
	DPDT	4PDT	
 (DPDT)	RN2S-NL-A24	RN4S-NL-A24	24V AC
	RN2S-NL-A115	RN4S-NL-A115	115V AC
	RN2S-NL-A220	RN4S-NL-A220	220V AC
	RN2S-NL-A230	RN4S-NL-A230	230V AC
	RN2S-NL-A240	RN4S-NL-A240	240V AC
	RN2S-NL-D12	RN4S-NL-D12	12V DC
	RN2S-NL-D24	RN4S-NL-D24	24V DC
	RN2S-NL-D48	RN4S-NL-D48	48V DC
 (4PDT)	RN2S-NL-D110	RN4S-NL-D110	110V DC

## Contact Ratings

Contact	Continuous Current	Allowable Contact Power		Rated Load		
		Resistive Load	Inductive Load	Voltage (V)	Resistive Load (Note)	Inductive Load (Note) cos $\phi$ = 0.4
DPDT	5A	1,250VA AC 150W DC	375VA AC	250 AC	5A	1.5A
				30 DC	5A	—
4PDT	3A	750VA AC 90W DC	250VA AC	250 AC	3A	1A
				30 DC	3A	—

## Approval Ratings

Voltage	c-UL Ratings		TÜV Ratings	
	Resistive		Resistive	
	DPDT	4PDT	DPDT	4PDT
250V AC	5A	3A	5A	3A
30V DC	5A	3A	5A	3A

## Coil Ratings

Rated Voltage (V)	Coil Voltage Code	Rated Current (mA) $\pm 15\%$ (at 20°C) (Reference Value)		Coil Resistance ( $\Omega$ ) $\pm 10\%$ (at 20°C)	Operating Characteristics (against rated values at 20°C)			Power Consumption
		50 Hz	60 Hz		Maximum Continuous Applied Voltage	Minimum Pickup Voltage	Dropout Voltage	
AC (50/60 Hz)	24V AC	A24	54.8	47.0	110%	80% maximum	30% minimum	Approx. 1.2VA
	115V AC	A115	11.7	10.0				
	220V AC	A220	7.6	6.6				
	230V AC	A230	6.4	5.9				
	240V AC	A240	6.3	5.4				
DC	12V DC	D12	71.2		110%	80% maximum	10% minimum	Approx. 0.9W
	24V DC	D24	42.6	640				
	48V DC	D48	23.5	2,600				
	110V DC	D110	13.4	13,000				

## Specifications

Model (Contact)		RN2S (DPDT)	RN4S (4PDT)
Contact Material		Silver alloy	
Contact Resistance (*1)		100 mΩ maximum	
Operate Time (*2)		20 ms maximum	
Release Time (*2)		20 ms maximum	
Power Consumption		AC: 1.02VA (50 Hz), 0.91VA (60 Hz) DC: 0.9 to 1.0W	
Insulation Resistance		100 MΩ minimum (500V DC megger)	
Dielectric Strength	Between contact and coil	2,000V AC, 1 minute	
	Between contacts of the same pole	1,000V AC, 1 minute	
	Between contacts of different poles	2,000V AC, 1 minute	
Vibration Resistance	Operating extremes	10 to 55 Hz, amplitude 1.0 mm	
	Damage limits	10 to 55 Hz, amplitude 1.0 mm	
Shock Resistance	Operating extremes	10G	
Electrical Life		100,000 operations minimum (operation frequency 1,800 operations per hour)	
Mechanical Life		10,000,000 operations minimum (operation frequency 18,000 operations per hour)	
Operating Temperature (*3)		RN2S: -40 to +45°C (no freezing) RN4S: -40 to +55°C (no freezing)	
Operating Humidity		35 to 85% RH (no condensation)	
Weight (approx.)		35g	

Note: Above values are initial values.

\*1) Measured using 24V DC, 1A voltage drop method.

\*2) Measured at the rated voltage (at 20°C), excluding contact bounce time.

\*3) 110% rated voltage.

## Applicable Socket

### DIN Rail Mount

Wiring Style	Type	Part No.	Applicable Spring
Screw Terminal	2-pole	SN2S-05D	SFA-502
	4-pole	SN4S-05D	
Finger-safe	2-pole	SM2S-05DF	
	4-pole	SY4S-05DF	

- See page 5 for details on sockets.
- For details on SM and SY sockets, see catalog.

## Dimensions

All dimensions in mm

### DPDT

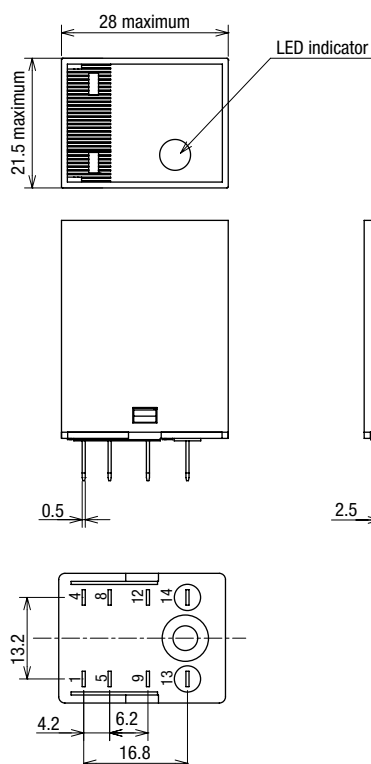

### 4PDT

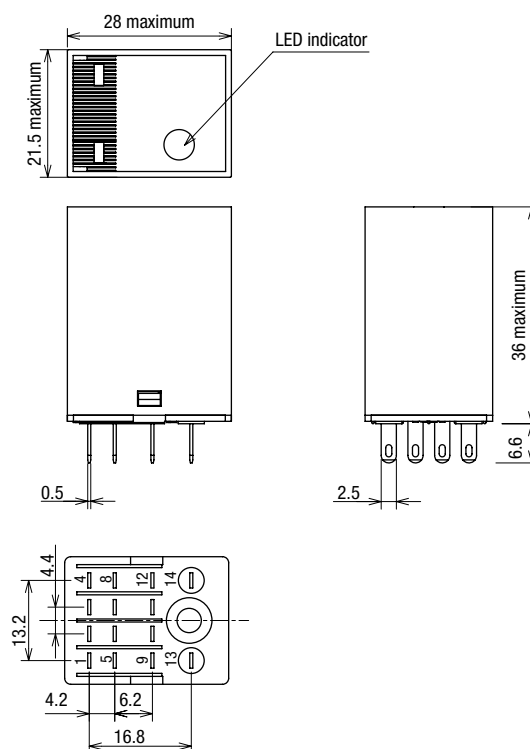

Characteristics (Reference Data)

Electrical Life Curves

DPDT

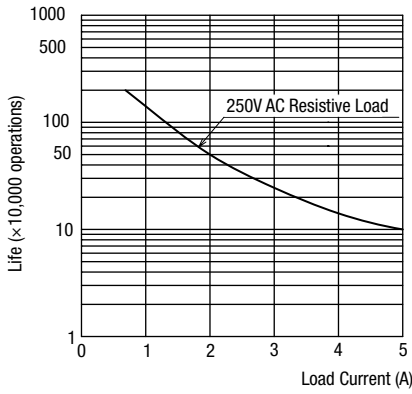

4PDT

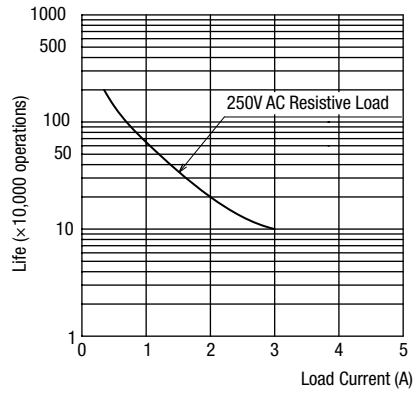

Internal Connection (Bottom View)

DPDT

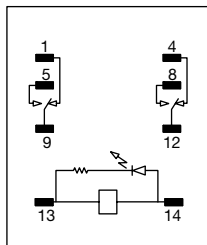

AC type

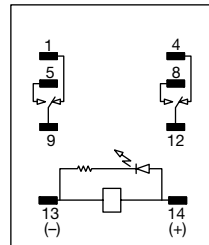

DC type

4PDT

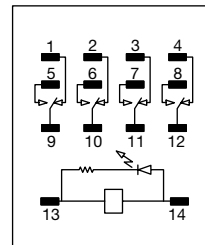

AC type

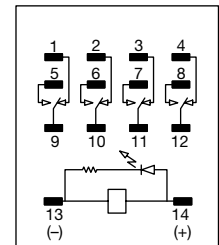



DC type

RM2/R4 Replacement List

RN Series Universal Relay		Part number of RY4 Series that can be replaced by RN Series		Part number of RM2 Series that can be replaced by RN Series	
		Basic	Indicator	Basic	Indicator
Contact	Part No.	Part No.		Part No.	
DPDT	RN2S-NL-A24	—	—	RM2S-UAC24	RM2S-ULAC24
	RN2S-NL-A115			RM2S-UAC110-120	RM2S-ULAC110-120
	RN2S-NL-A220			RM2S-UAC220-240	RM2S-ULAC220-240
	RN2S-NL-A230			—	—
	RN2S-NL-A240			—	—
	RN2S-NL-D12			RM2S-UDC12	RM2S-ULDC12
	RN2S-NL-D24			RM2S-UDC24	RM2S-ULDC24
	RN2S-NL-D48			RM2S-UDC48	RM2S-ULDC48
	RN2S-NL-D110			RM2S-UDC100-110	RM2S-ULDC100-110
4PDT	RN4S-NL-A24	RY4S-UAC24	RY4S-ULAC24	—	—
	RN4S-NL-A115	RY4S-UAC110-120	RY4S-ULAC110-120		
	RN4S-NL-A220	RY4S-UAC220-240	RY4S-ULAC220-240		
	RN4S-NL-A230	—	—		
	RN4S-NL-A240	—	—		
	RN4S-NL-D12	RY4S-UDC12	RY4S-ULDC12		
	RN4S-NL-D24	RY4S-UDC24	RY4S-ULDC24		
	RN4S-NL-D48	RY4S-UDC48	RY4S-ULDC48		
RN4S-NL-D110	RY4S-UDC100-110	RY4S-ULDC100-110			

# SN Series Sockets

## SN Series

Shape		
No. of Poles	2-pole	4-pole
Part No.	SN2S-05D	SN4S-05D

## Specifications

Model	SN2S-05D	SN4S-05D
Rated Current	10A	6A
Rated Insulation Voltage	300V	
Applicable Wire	0.5 to 2.5mm <sup>2</sup>	
Applicable Crimping Terminal	1.25mm <sup>2</sup> ×2	
Recommended Tightening Torque	0.8N·m	
Screw Terminal Style	M3 slotted Phillips screw	
Insulation Resistance	100MΩ minimum (500V DC megger)	
Dielectric Strength	2,000V AC, 1 minute	
Vibration Resistance	10 to 55 Hz, amplitude 1.0 mm	
Operating Temperature	SN2S: -40 to +70°C (no freezing) SN4S: -40 to +70°C (no freezing)	
Operating Humidity	35 to 85% RH (no condensation)	
Weight (approx.)	34g	56g

## Applicable Relay

2-pole		4-pole	
Socket	Relay	Socket	Relay
SN2S-05D	RN2S RU2S (Note)	SN4S-05D	RN4S RU4S

- See page 3 for details on relays.
- For details on RU relays, see catalog.

When using the RU2S relay with SN2S socket, be sure to note the derating characteristics.

## Derating Curve

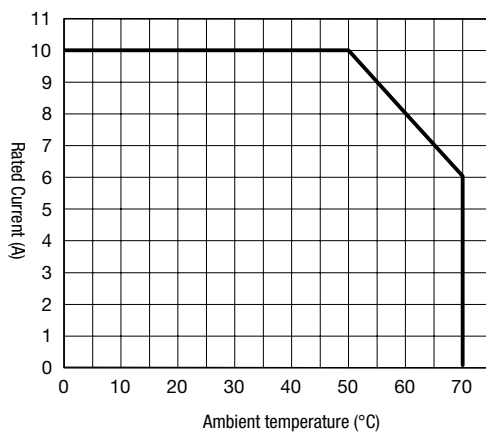

Dimensions

All dimensions in mm

DPDT

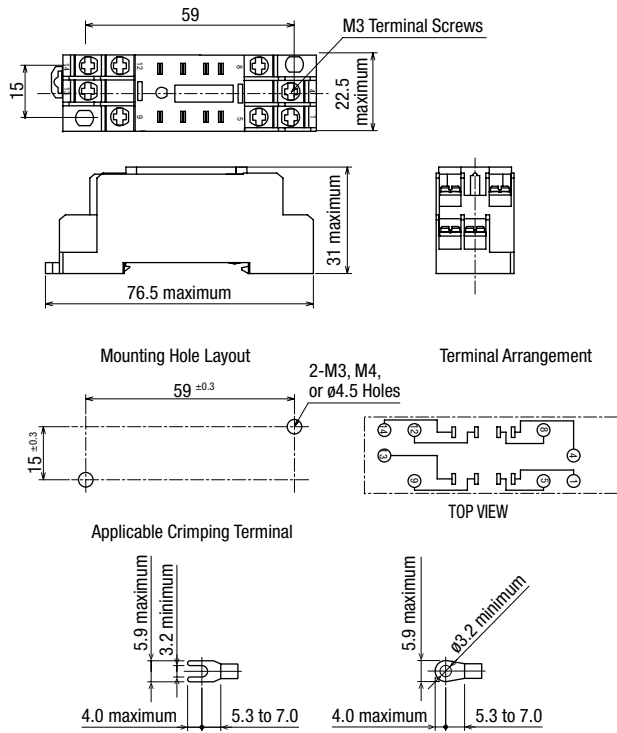

4PDT

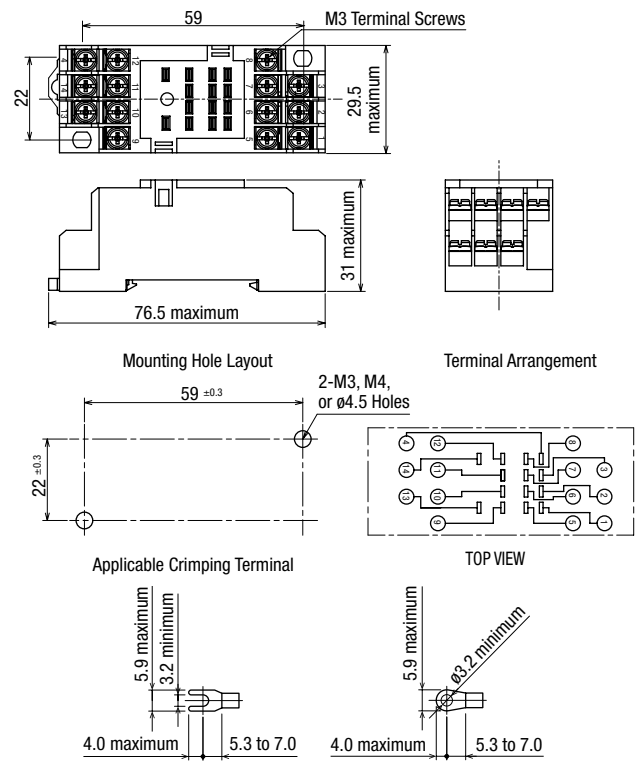

Hold-down Spring

Item	Shape	Part No.	Ordering No.	Package Quantity	Remarks
Wire Spring		SFA-502	SFA-502PN20	20 (10 pairs)	Material: SUS Two leaf springs are used for one relay.

## ⚠ Safety Precautions

- Turn off the power to the relay before starting installation, removal, wiring, maintenance, and inspection of the relays. Failure to turn power off may cause electrical shock or fire hazard.
- Observe specifications and rated values, otherwise electrical shock or fire hazard may be caused.

## Instructions

### Driving Circuit for Relays

1. To make sure of correct relay operation, apply rated voltage to the relay coil.
2. Input voltage for the DC coil:

A complete DC voltage is best for the coil power to make sure of stable relay operation. When using a power supply containing a ripple voltage, suppress the ripple factor within 5%. When power is supplied through a rectification circuit, the relay operating characteristics, such as pickup voltage and dropout voltage, depend on the ripple factor. Connect a smoothing capacitor for better operating characteristics as shown below.

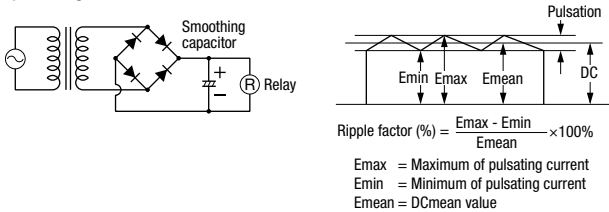

3. Operating the relay in synchronism with AC load:  
If the relay operates in synchronism with the AC power voltage of the load, the relay life may be reduced. If this is the case, select a relay in consideration of the required reliability for the load. Or, make the relay turn on and off irrespective of the AC power phase or near the point where the AC phase crosses zero voltage.

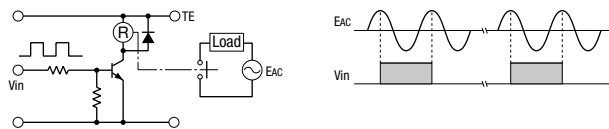

4. Leakage current while relay is off:  
When driving an element at the same time as the relay operation, a special consideration is needed for the circuit design. As shown in the incorrect circuit below, Leakage current ( $I_0$ ) flows through the relay coil while the relay is off. Leakage current causes the coil release failure or adversely affects the vibration resistance and shock resistance. Design a circuit as shown in the correct example.

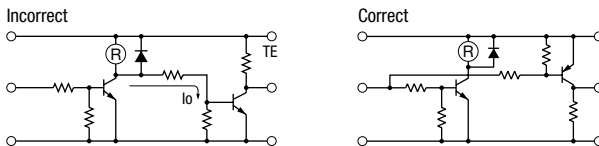

5. Surge suppression for transistor driving circuits:  
When the relay coil is turned off, a high-voltage pulse is generated, causing the transistor to deteriorate and sometimes to break. Be sure to connect a diode to suppress the counter electromotive force. Then, the coil release time becomes slightly longer. To shorten the coil release time, connect a Zener diode between the collector and emitter of the transistor. Select a Zener diode with a Zener voltage slightly higher than the power voltage.

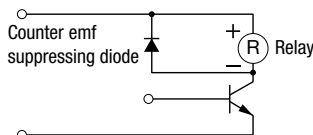

- Use wires of the proper size to meet the voltage and current requirements. Tighten the terminal screws on the relay socket to the proper tightening torque.

6. The coil terminal of the DC relay has polarity. Connect terminals according to the internal connection diagram. Incorrect wiring may cause malfunction.

### Protection for Relay Contacts

1. The contact ratings show maximum values. Make sure that these values are not exceeded. When an inrush current flows through the load, the contact may become welded. If this is the case, connect a contact protection circuit, such as a current limiting resistor.
2. Contact protection circuit:

When switching an inductive load, arcing causes carbides to form on the contacts, resulting in an increased contact resistance. In consideration of contact reliability, contact life, and noise suppression, use of a surge absorbing circuit is recommended. Note that the release time of the load becomes slightly longer. Check the operation using the actual load. Incorrect use of a contact protection circuit will adversely affect switching characteristics. Four typical examples of contact protection circuits are shown in the following table:

RC		This protection circuit can be used when the load impedance is smaller than the RC impedance in an AC load power circuit. R: Resistor of approximately the same resistance value as the load C: 0.1 to 1 $\mu\text{F}$
		This protection circuit can be used for both AC and DC load power circuits. R: Resistor of approximately the same resistance value as the load C: 0.1 to 1 $\mu\text{F}$
Varistor		This protection circuit can be used for both AC and DC load power circuits. For a best result, when using on a power voltage of 24 to 48V AC/DC, connect a varistor across the load. When using on a power voltage of 100 to 240V AC/DC, connect a varistor across the contacts.

3. Do not use a contact protection circuit as shown below:

	This protection circuit is very effective in arc suppression when opening the contacts. But, the capacitor is charged while the contacts are opened. When the contacts are closed, the capacitor is discharged through the contacts, increasing the possibility of contact welding.
	This protection circuit is very effective in arc suppression when opening the contacts. But, when the contacts are closed, a current flows to charge the capacitor, causing contact welding.

Instructions

**Mounting Direction**

Relay direction must be taken into consideration when installing the relay so that shock noise resistance, life, contact reliability is maintained.

• **Shock Resistance**

To maintain shock resistance, it is ideal to mount the relay so that the armature movement is perpendicular to the direction of vibration and shock.

• **Life**

Large load that causes arcs may result in the contact material scattered off, accumulating around the contact. This will degrade insulation resistance between the circuits. Make sure that relay is mounted in the correct direction.

• **Contact Reliability**

It is not desirable for a single relay to switch both large and low level load. The scattered contact material produced when switching the large load adheres to the contacts when switching the low level load and may cause contact failure. Therefore, when multi-pole relay, avoid install the relay in the direction where the low level contacts comes below the large load. Also avoid terminal connection.

**Usage, transport, and storage conditions**

• **Condensation**

Condensation occurs when there is a sudden change in temperature under high temperature and high humidity conditions. The relay insulation may deteriorate due to condensation.

• **Freezing**

Condensation or other moisture may freeze on the relay when the temperatures is lower than 0°C. This causes problems such as sticking of movable parts or delay in operation.

• **Low temperature, low humidity environments**

Plastic parts may become brittle when used in low temperature and low humidity environments.

**Other Precautions**

1. General notice:

- To maintain the initial characteristics, do not drop the relay or shock the relay.
- The relay cover cannot be removed from the base during normal operation. To maintain the initial characteristics, do not remove the relay cover.
- Use the relay in environments free from condensation of dust, sulfur dioxide (SO<sub>2</sub>), and hydrogen sulfide (H<sub>2</sub>S).
- Make sure that the coil voltage does not exceed the applicable coil voltage range.

2. Connecting outputs to electronic circuits:

When the output is connected to a load which responds very quickly, such as an electronic circuit, contact bouncing causes incorrect operation of the load. Take the following measures into consideration.

- Connect an integral circuit.
- Suppress the pulse voltage due to bouncing within the noise margin of the load.

3. UL- and CSA-approved ratings may differ from product rated values determined by IDEC.

4. Do not use relays in the vicinity of strong magnetic field as this may affect relay operation.

**Socket Safety Precautions**

- Turn off power to the socket before starting installation, removal, wiring, maintenance, and inspection of the relays. Failure to turn power off may cause electrical shock or fire hazard.
- Do not pull the wire in the vertical direction from the screw washer when wiring. The tension force of the wire in a horizontal direction should not exceed 50N.

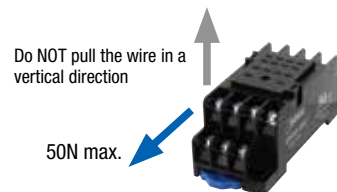

- Observe specifications and rated values, otherwise electrical shock or fire hazard may be caused.

**IDEC CORPORATION**

**Head Office**

6-64, Nishi-Miyahara-2-Chome, Yodogawa-ku, Osaka 532-0004, Japan

<b>USA</b>	IDEC Corporation	Tel: +1-408-747-0550	opencontact@idec.com	<b>Hong Kong</b>	IDEC Izumi (H.K.) Co., Ltd.	Tel: +852-2803-8989	info@hk.idec.com
<b>Germany</b>	APEM GmbH	Tel: +49-40-25 30 54 - 0	service@eu.idec.com	<b>China/Shanghai</b>	IDEC (Shanghai) Corporation	Tel: +86-21-6135-1515	idec@cn.idec.com
<b>Singapore</b>	IDEC Izumi Asia Pte. Ltd.	Tel: +65-6746-1155	info@sg.idec.com	<b>China/Shenzhen</b>	IDEC (Shenzhen) Corporation	Tel: +86-755-8356-2977	idec@cn.idec.com
<b>Thailand</b>	IDEC Asia (Thailand) Co., Ltd	Tel: +66-2-392-9765	sales@th.idec.com	<b>China/Beijing</b>	IDEC (Beijing) Corporation	Tel: +86-10-6581-6131	idec@cn.idec.com
<b>Australia</b>	IDEC Australia Pty. Ltd.	Tel: +61-3-8523-5900	sales@au.idec.com	<b>Japan</b>	IDEC Corporation	Tel: +81-6-6398-2527	marketing@idec.co.jp
<b>Taiwan</b>	IDEC Taiwan Corporation	Tel: +886-2-2698-3929	service@tw.idec.com				

 [www.idec.com](http://www.idec.com)

Specifications and other descriptions in this brochure are subject to change without notice. Information in this brochure is current as of August, 2019. 2019 IDEC Corporation, All Rights Reserved.

EP1688-1

